

Vocabulary Development

Prior to teaching a course, unit or even lesson, a teacher should select a list of words necessary to the understanding of the content. The vocabulary selected may be new to the students, or may be those introduced at a previous time. Even though a term may have been taught in a previous course, detail and breadth must be added to develop a mature understanding. The list may also include language that needs to be reviewed to help student access background knowledge.

Once the list of words has been selected, these six steps are necessary to effective instruction. (Building Background Knowledge, Marzano, 2004):

1. The **teacher provides a description or an explanation** rather than a definition. In fact, research indicates that definitions are rather useless in effective instruction.
2. **Students restate the explanation** IN THEIR OWN WORDS.
3. **Students create nonlinguistic representation(s)** for the term.
4. **Students periodically do activities that help them add to their knowledge** of vocabulary terms. Teachers give students multiple, varied exposures to the terms.
5. Students are periodically asked to **discuss the terms with one another** in small groups.
6. Periodically **students are involved in games** or game-like activities that allow them to play with the vocabulary terms.

The pages that follow contain instructional strategies, ideas and activities for each of the steps listed above. See the index for page numbers.

Step 1: Teacher Provides A Description And Explanation

Examples, non-examples, synonyms, related phrases and antonyms for the vocabulary term may be a helpful part of the description and explanation. These should be selected according to their appropriateness for the grade or course level. One or more of the following ideas may be used to provide the description and explanation. Most of these activities can also be used for step four.

Identify the category

Before describing and explaining, identify the category of a term. The term may belong in a noun category such as an object, an event or a state. Perhaps the term is a verb category such as an action or state of being. Though identifying a category need not be part of the instruction, this helps the teacher emphasize whether the term should invoke action, visualization or an abstract understanding. If the term is a concrete noun, it can be described. However, if the term is abstract, examples must be shown. For example, *Bar Graph* or *radius* can be described or visualized, but *mean* or *less than* require examples.

A verb requires noun terms also be used to give the action or state of being meaning. For example *find* requires a noun phrase such as *the probability* in order to have meaning. The verbs *simplify* or *round* must also be followed by noun text, whether it be words or mathematical symbols, in order to be meaningful.

Describe and explain through conversation-not through definition

Descriptions and explanations should NOT be definitions, but rather conversational where all the elements important to understanding the word at a course or grade level are described and explained. For example, in explaining *multiplicative inverse*, a teacher might have a student stand on his/her head to demonstrate, might show some examples such as $\frac{3}{4}$ and $\frac{4}{3}$ or 2 and $\frac{1}{2}$. The teacher might emphasize the root *multiply* and may give synonyms and related ideas such as *reciprocal* and *invert*. This would all be part of the explanation.

Emphasize prefixes, suffixes and root words

Another consideration might be the emphasis of prefixes, suffixes or root words that help students connect meaning to familiar or related ideas. Emphasizing roots such as *add* in the words *addition*, *addend* and *added*, or meaning of *poly*, *pent*, *hex* and *oct* in the words *polygon*, *pentagon*, *hexagon* and *octagon* can be helpful. Identifying the word part *multi* in *multiply*, *multiple*, and *multiplicative* can aid comprehension. Questions such as, “Where have we heard/seen this part of the word before?” can help students connect previous vocabulary meaning to the term.

Anticipation Guides

This strategy is especially effective as a pre-reading strategy when the vocabulary is contained in text. Identify the vocabulary or concepts you want the students to learn, then write four to six statements. These statements should include correct, defining ideas as well as misunderstandings students often have. Before students read the text, have them individually, or in small groups respond in the “Me” column to the statements you have written. Ask students to explain their responses and reasoning. Next, have students read the text and use the “Text” column to check those statements the text agrees with. Ask them to compare their opinions to the text information. Have them look for the actual words or phrases in the text that refute their opinions. They should indicate these words or phrases in the “Evidence” column. Have students rewrite the incorrect statements to make them true. See the following examples.

Anticipation Guide for <i>Multiple</i>			
Me	Text	Statements	Text Evidence
_____	_____	1. Multiples relate to multiplying.	
_____	_____	2. 0 is a multiple of any number	
_____	_____	3. 0 is a divisor of any number.	
_____	_____	4. Multiples of 2 are called even numbers.	
_____	_____	5. Multiples of 1 are called odd numbers.	
_____	_____	6. Every number is a multiple of itself.	

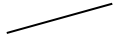
Anticipation Guide for <i>Slope</i>			
Me	Text	Statements	Text Evidence
_____	_____	1. Slope refers to the steepness of a line.	
_____	_____	2. A straight line has several different slopes.	
_____	_____	3. Slope can be written as a ratio.	
_____	_____	4. A vertical line has a slope of 0.	
_____	_____	5. Slope is the ratio of the change in the y values over the change in x values.	
_____	_____	6. This line  has a positive slope.	

Predicting from context

Have students read an unfamiliar vocabulary term in the context of a sentence or situation. Ask them to **write their prediction** for what the word means. Encourage students to share their predicted meanings, and ask them to explain what part of the reading helped them make this prediction. Correct, clarify or expand the meaning. Ask the students to predict what the meaning of *probability* is in this example:

My coin purse contained five pennies, two nickels, a dime, and a quarter. If I reach inside to take out a coin without looking, what is the probability I will pull out a nickel?

Suggest synonyms or related words or phrases

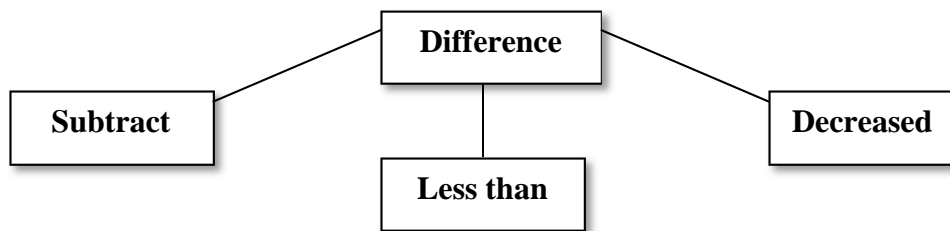

Comparing examples and non-examples

Identifying similarities and differences is a very powerful strategy for learning. Showing examples and non-examples helps students compare characteristics in order to develop meaning for vocabulary terms. One way to do this is to use a **Two-Column Comparison**. Tell the students you are going to show them some examples of the term you are teaching in Column One and some non-examples in Column Two. Ask the students to look for differences between the examples and non-examples to identify a characteristic or quality existing in Column One that does not exist in Column Two. Show an example in column one and a non-example in column two. Then, show another example in column one and a non-example in column two and so on. Ask the students to suggest characteristics that qualify an example to be placed in Column One rather than in Column Two, or ask them to give you additional examples they believe belong in Column One and to explain why they chose the examples. Use the characteristic(s) described by the students to explain the term.

Here's an example of a Two-Column Comparison for "*algebraic expression*". Students may identify the existence of a variable as the qualifying characteristic for terms in column one. The second example is for "*prime number*". When using a comparison to explain or describe, always choose the most obvious example possible to avoid confusion about the meaning

n	-10	5	4
$3x$	$3(5)$	7	6
$-4 + 2m$	$7 + (-5)$	11	9
$x^2 + 6x + 12$	$25 + 2(15) + 9$	19	18
xyz	$\frac{1}{3} \cdot \frac{1}{2} \cdot \frac{1}{4}$	29	25
		37	

Another idea for a comparison is to simply **show several examples** and ask student to identify any characteristic(s) the examples have in common. When introducing vocabulary, use the most obvious examples possible to access background knowledge rather than confusing.

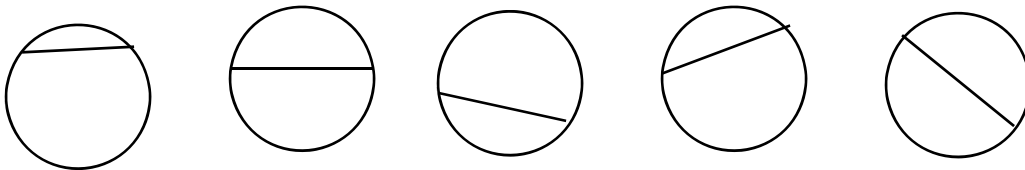

Use the characteristics they suggest to describe and explain the vocabulary. Students may suggest a segment with endpoints on the circumference. Teacher can then introduce *chord*.

Here's an example for *prime number*: 3, 5, 7, 11, 13, 29, 47... Have students look for a common characteristic. If they notice that the ones digit is odd, add 2 to the list.

Use of analogies

Present the vocabulary word as part of an analogy as shown in the following.

- 0 is to *Identity Property of Addition* as 1 is to _____ (Identity Property of Multiplication)
- *Opposite side* is to *sine as adjacent side* is to _____ (cosine)
- *Gram* is to *weight as meter* is to _____ (distance or length)
- *Sum* is to *addition* as _____ is to *multiplication* (product)

Label Parts

Labeling parts as expressions or equations are formed can help students learn vocabulary and the relationships among vocabulary words.

$$y = \frac{1}{2}x + (-4) \quad (2, -3)$$

y-value slope x-value y-intercept x-value, y-value

$$12 \div 3 = 4 \quad 3. \underline{1}75 \text{ hundredths place}$$

dividend divided by divisor equals quotient

Shape or Design Words to Give Meaning and Description

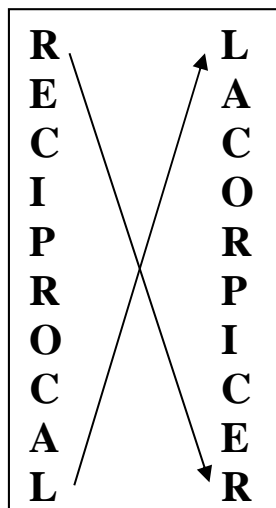
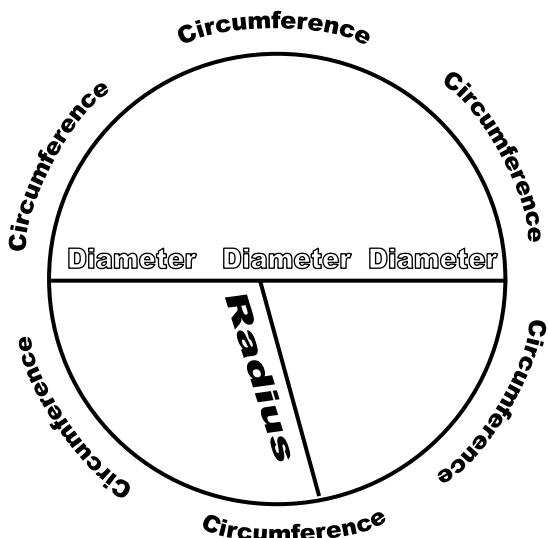

parabola

E = qua + tion

Step 2: Students Restate In Their Own Words

Once the word or phrase has been described and explained by the teacher, students need to restate in their own words. This is the beginning of several steps where students actively and repeatedly process information in order to store meaning in long term or permanent memory. In this step, discourse and writing are essential. Following are some ideas to help students restate the teacher’s description or explanation in their own words.

The Academic Notebook or Journal

Research indicates this is one of the most effective strategies for processing information. Care should be taken to insure that students DO NOT merely copy the teacher’s explanation or representations, but rather construct their own (Marzano). As the teacher presents new or review vocabulary, students record the terms in their notebooks. Several words could be included on each page. The step of restating the information involves only the first two columns. The last two columns include the next three steps in teaching vocabulary, so this strategy can be used for several steps in effective instruction. A notebook page could look like this:

Vocabulary For Mathematics		Name _____	
Word or Phrase	Description or Explanation	Examples	New Insights
equivalent	Something that has the same value as another thing or that is the same measurement as another thing is equivalent.	$\frac{1}{2}$ is equivalent to $\frac{3}{6}$ 1 yard is equivalent to 36 inches $2(3 + 5)$ is equivalent to $2 \cdot 3 + 2 \cdot 5$	I learned about how properties make expressions equivalent like the distributive property.

The Frayer Model (modified)

Students often have difficulty restating the explanation the teacher has given. The Frayer model can help them put words to their ideas. In this model, The description or explanation is written after the facts, diagrams or sketches, and after the examples and non examples have been discussed.

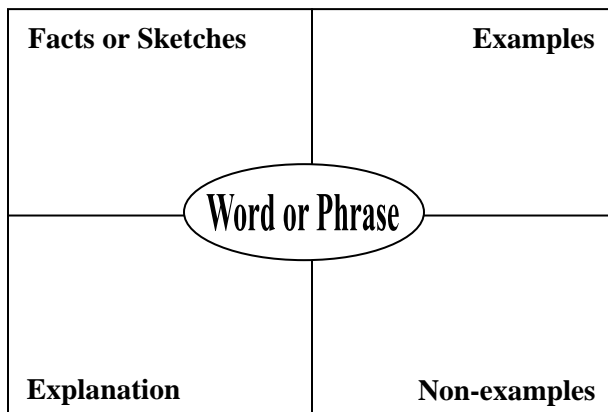

Here's an example of the Frayer Model for the phrase, *rational number*.

<p>Facts, Sketches</p> <ul style="list-style-type: none"> • All fractions are rational numbers. • Repeating decimals are rational numbers. • Whole numbers and integers are rational numbers • any number that could be written as a fraction 	<p>Examples</p> <p>0.333... 26.5 .0001</p> <p>$\frac{1}{2}, \frac{3}{4}, 4\frac{2}{3}$ 1, 2, 3, 4</p> <p>0, -1, -2, -3, -4</p>
<p>Rational Numbers</p>	
<p>Explanation</p> <p>A rational number is any number that could be written as a fraction. Rational numbers include all fractions, repeating or terminating decimals, percents, whole numbers and integers.</p>	<p>Non examples</p> <p>$\sqrt{3}$ π</p>

VOC Strategy

This strategy helps students analyze word meanings from text in context.

Before students read a passage, list the key vocabulary word(s) they need to understand. Have the student read a passage. Have them identify the unfamiliar terms on the list and to learn their meaning using the VOC strategy (see form). Encourage them to share their strategies for remembering a word's meaning.

This strategy implements Steps 1, 2 and 3.

Student VOC Strategy	Name _____
Vocabulary word: _____	
1. Write the sentence in which it appears in the text:	
2. Based on how it is used in the text, predict what the word means.	
3. Consult an "expert" for a definition, description or explanation (e.g., a teacher, friend, text). Who is the expert? Expert's explanation:	
4. Show your understanding of the word by using it in a sentence of your own.	
5. Choose one of the following ways to help you remember the word's meaning: Draw a picture of what the word means to you, select and perform a mime action that the word reminds you of, write a poem or song; or connect the word with something similar that you've hear—in a story, a news report, or book. Describe what you will do to help you remember the meaning of the word:	
6. Explain why you chose this way to represent what the word means to you:	

Here is an example of a VOC for the phrase, *scale factor*.

Student VOC Strategy	Name _____
Vocabulary word: <u>scale factor</u>	
1. Write the sentence in which it appears in the text: <i>Use a scale factor greater than 1 to enlarge the diagram</i>	
2. Based on how it is used in the text, predict what the word means. <i>A multiplier</i>	
3. Consult an “expert” for a definition, description or explanation (e.g., a teacher, friend, text). Who is the expert? <i>The text</i> Expert’s explanation: <i>The factor by which all parts of an object are multiplied to create a proportional enlargement or reduction</i>	
4. Show your understanding of the word by using it in a sentence of your own. <i>Using a scale factor of 3 on a 2” by 2” square will result in a square that is 6” by 6”.</i> <i>Using a scale factor of 1/2 will result in a 1” by 1” square.</i>	
5. Choose one of the following ways to help you remember the word’s meaning: Draw a picture of what the word means to you, select and perform a mime action that the word reminds you of, write a poem or song; or connect the word with something similar that you’ve hear—in a story, a news report, or book. Write down the association that helped you remember the meaning of the word: <div style="text-align: center;"><p><i>The Scale Factor Machine</i></p></div>	
6. Explain why you chose this way to represent what the word means to you: <i>I think the Scale Factor Machine works because all the parts would be enlarged or reduced the same amount. Everything part is affected.</i>	

This can be streamlined by discussing a prediction, then having students look up the word in a dictionary or glossary and compare meanings. Then, students are asked to go to the next step creating a nonlinguistic representation to help them remember the meaning.

Step 3: Students Create Non-Linguistic Representations

This step is best done immediately after the student write their own descriptions and explanations for the vocabulary. Studies show that in order to move knowledge into permanent memory students must have access to linguistic (language based) *and* non-linguistic (imagery based) representations. Once the meaning is in permanent memory, it becomes background knowledge, essential for learning. Non-linguistic representations can be categorized as, a) graphic organizers, b) pictures, and c) pictographs (a combination of words and pictures). Each category has its advantages. Here are some examples of each.

Graphic Organizers

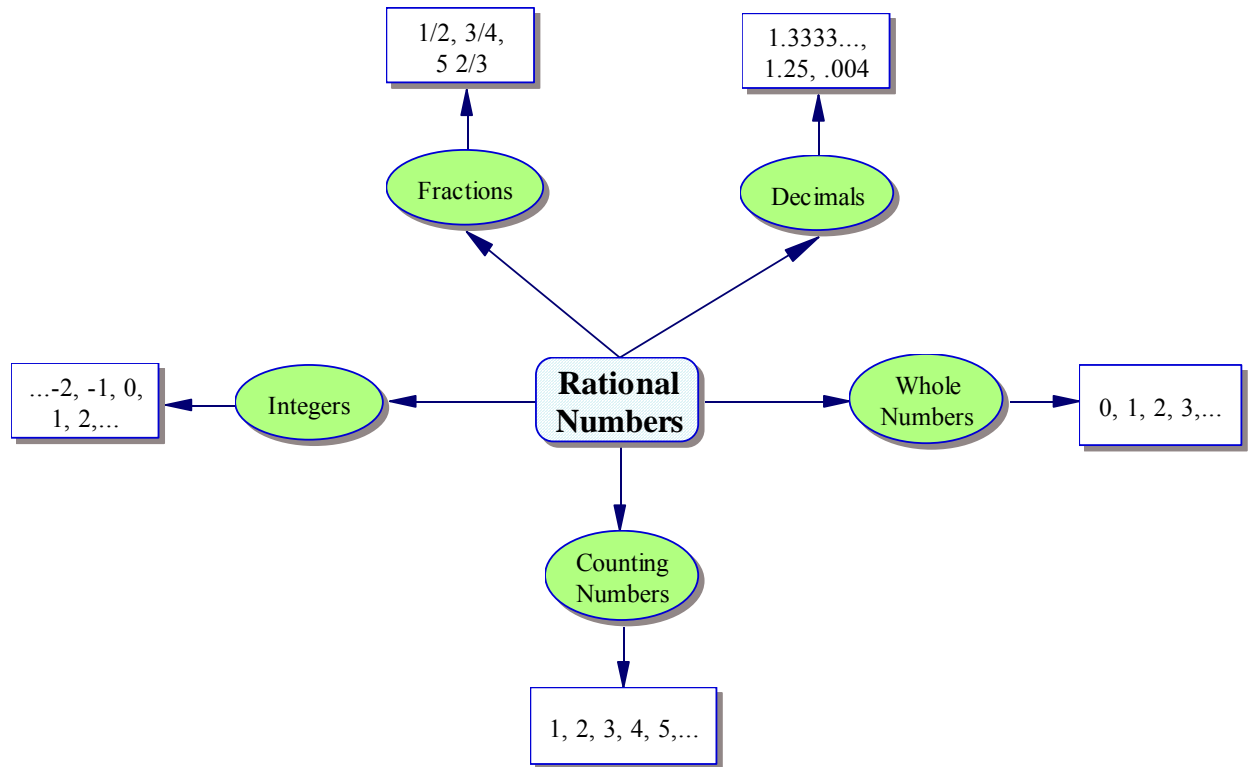
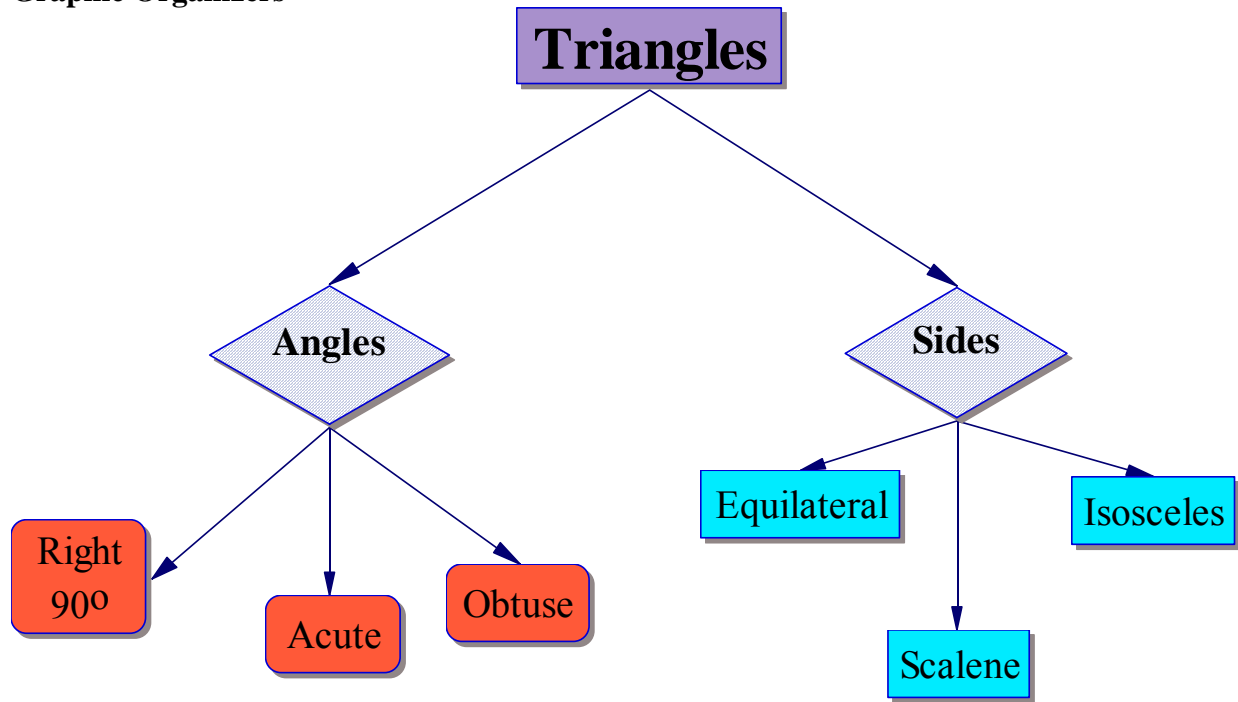

Using Prime Factorization to Find GCF and LCM

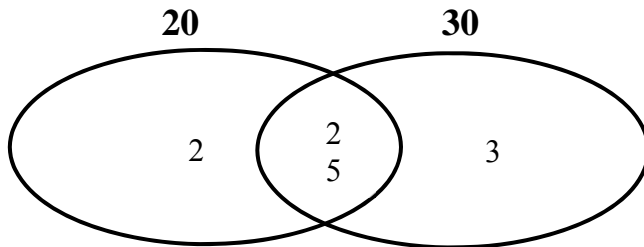

Greatest common Factor is $2 \cdot 5$, or 10
 Least Common Multiple is $2 \cdot 2 \cdot 5 \cdot 3$, or 60

A Venn Diagram can be used in a number of ways to represent understanding in a nonlinguistic way.

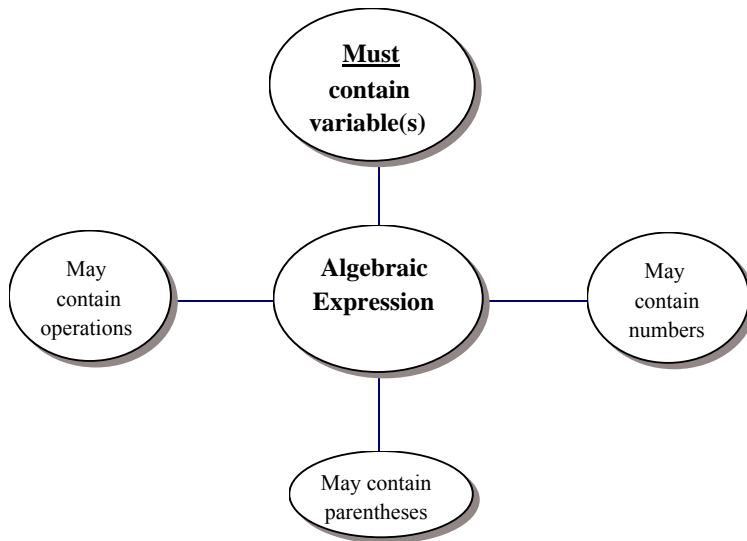

Describing a vocabulary term can be done using this type of graphic organizer where the phrase is centered among its characteristics.

Sketches are especially effective for younger students or for using a story to describe a term as show in the next two examples.

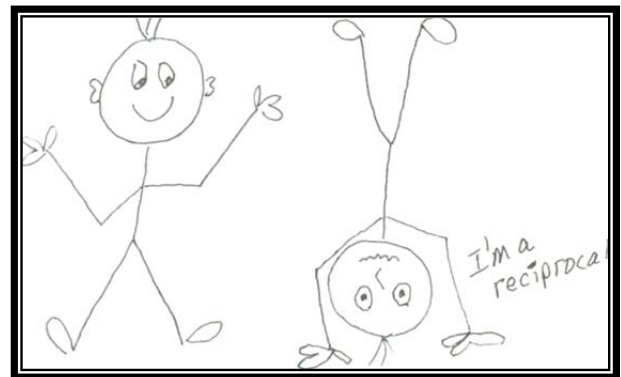
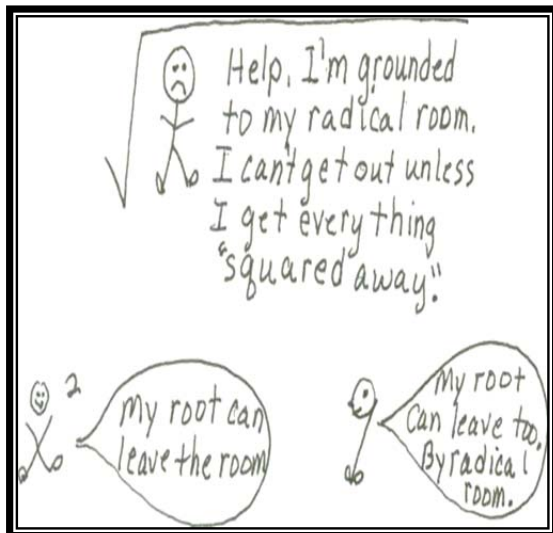

This sketch shows a complicated procedure in a graphic representation.

Similar to the Frayer Model is another graphic organizer students may use as a non linguistic representation. This model is known as a **Verbal and Visual Word Association**. In this model, students visualize a real-world connection or example.

Vocabulary Term	Visual Representation
Definition (in student words)	Personal Association or Characteristic

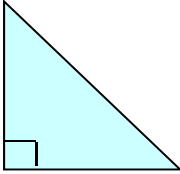
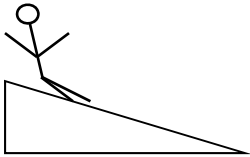
Right Triangle	
A triangle with a ramp or slide one right (90°) angle It has one square corner.	

Diagrams and Number Lines

A graphic organizer can also be a simple diagram or number line such as those shown below for metric measurement and integer addition

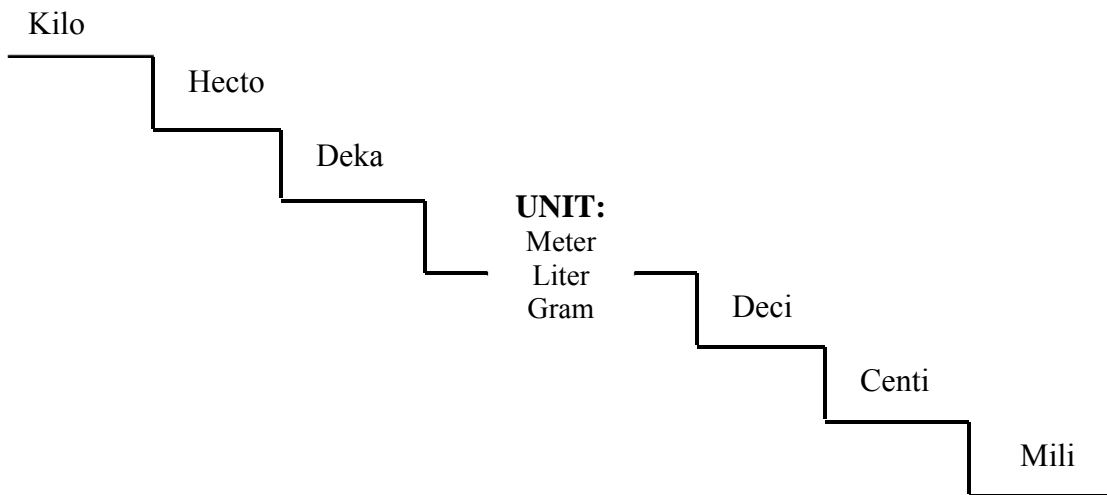

$$-5 + 3 = -2$$

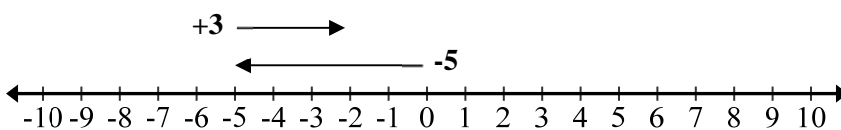

Step 4: Students Do Activities For Adding Knowledge

Multiple exposures to vocabulary through varied experiences will move add depth and breadth to students understanding of mathematical vocabulary. Without this step, students never develop more than a very basic meaning for concepts. To understand this, consider a student’s understanding of a *square* in Kindergarten compared to the meaning they have developed by the time they finish a Geometry Course. Understandings of characteristics such as right angles, congruent sides, congruent diagonals, and opposite sides being parallel have been added to the mere recognition of the shape that a Kindergarten student understands.

To provide opportunities for students to engage in multiple experiences, teachers should plan activities that allow them to interact with vocabulary in a variety of ways. These might include:

- Comparing
- Classifying
- Generating metaphors using the terms
- Creating analogies using the terms
- Revising initial descriptions and understandings
- Revising non-linguistic representations of the vocabulary
- Using roots and affixes to deepen knowledge of the term.

Any of the activities shown for the previous three steps may be used at this step for adding knowledge. For example, the following graphic organizers have been used to add to definition.

This graphic organizer shows how the definition for proportion has been expanded to include possible

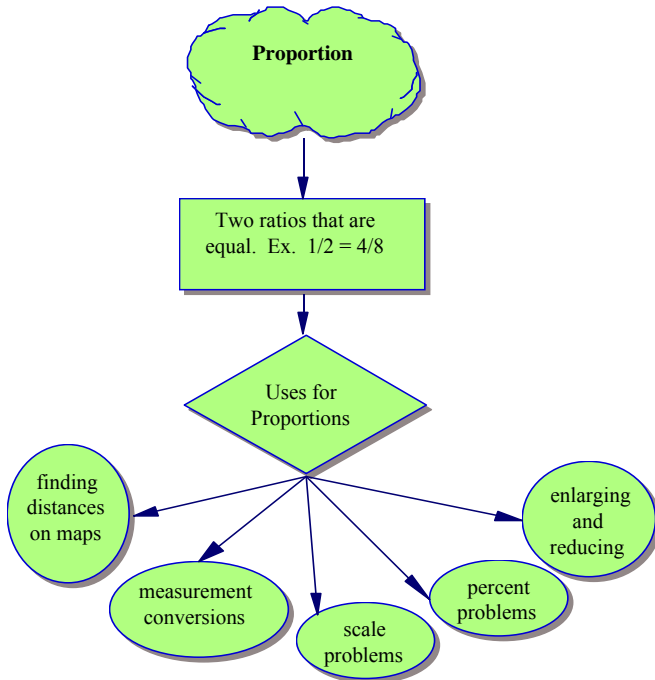

This graphic organizer shows how a matrix has been used to help add knowledge of the characteristics of quadrilaterals.

Terms	Features/Properties	diagonals are congruent	diagonals are perpendicular	diagonals bisect each other	all sides are congruent	all angles are congruent
parallelogram			X			
rhombus		X	X	X		
square	X	X	X	X	X	X
rectangle	X		X			X
trapezoid						
kite		X				

Categorizing

A word sort can be used for any lesson to include literally any list of vocabulary as well as review words. Students categorize a list of words and explain their rule or reason for sorting as they did. Categorizing requires comparing, organizing knowledge and identifying characteristics, all important in adding to knowledge. Here are examples of categorizing.

Vocabulary Term: Measurement

Word List:			
weight	height	meter	length
foot	pound	mile	width
tape measure	circumference	area	perimeter
scale	radius	distance	ruler
age	quart	time	temperature
cup	yard	kilogram	thermometer

Here, the Word List above has been categorized by students.

<u>Units of Measure</u>	<u>Things You Measure</u>	<u>Tools for Measurement</u>
foot	weight	tape measure
pound	age	scale
yard	height	cup
quart	circumference	ruler
meter	radius	thermometer
mile	area	
kilogram	distance	
	time	
	length	
	width	
	perimeter	
	temperature	

Category: Whole Numbers

Directions: Sort the numbers into at least three categories. Label your categories. A number may be listed in more than one category.

1	3	4	5	6	7	9	10	11	13
15	16	21	25	28	31	36	37	45	49

Categorized by students

<u>Prime Numbers</u>	<u>Square</u>	<u>Triangular Numbers</u>
3	1	1
5	4	3
7	9	6
11	16	10
13	25	15
31	36	21
37	49	28
		36
		45

Finding unrelated terms

Choose common attributes or relationships among a number of terms to be placed in a list. Include one or two terms that do not have the attribute. Have students find the word(s) that do not belong. Students should justify their choice as they share their ideas with others.

Circle the unrelated term(s) in the list

Explain why the word(s) you circled do not belong in the list.

x -intercept	slope	linear equation	line
ordered pairs	x squared	0 slope	function
horizontal line	absolute value	y -intercept	parabola

Circle the unrelated term(s) in the list

Explain why the word(s) you circled do not belong in the list.

associative	commutative	identity
addition	subtraction	multiplication

Which word does not belong?
Explain why you think so.

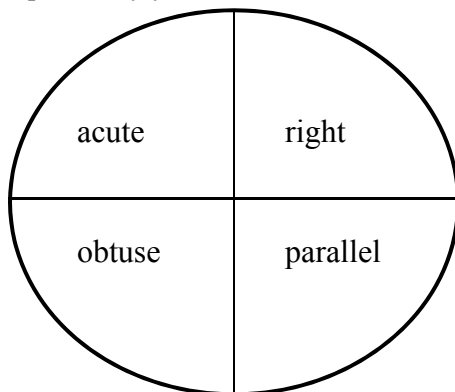

Concept: quadrilaterals

Which quadrilateral does not belong? Explain why.

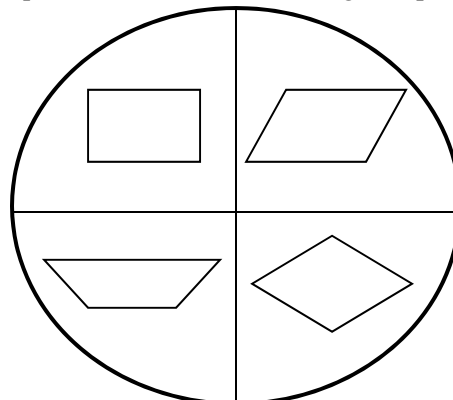

Songs and Rhymes

The use of music and rhythm is a very effective strategy for moving information into permanent memory. Teachers mistakenly think songs and rhymes are only effective for younger students. This is not true. The songs or rhymes can be generated by the teacher or by the student. Here are a couple of examples.

Area and Volume

(Tune: The Farmer in The Dell)

Cover it up with squares. Cover it up with squares.
That is the area. Cover it up with squares.
Fill it up with cubes. Fill it up with cubes.
That is volume. Fill it up with cubes.

Finding GCF With Prime Factorization

(Tune: Three Blind Mice)

Greatest Common Factor
Greatest Common Factor
We only use
We only use
The factors which both the numbers share
Use only the twin factors of the pair
In both numbers the factor must be there
For the Greatest Common Factor

Acrostic poetry can also help students look for pertinent information. Acrostic poetry uses each of the letters in the word like this:

Slope

Steepness of a line Steepness of a line
Lines have a constant slope
Ordered pairs change at the same rate
Put the change in y over the change in x
Every line has a slope except a vertical line

Obtuse Angle

Over 90°
Bigger than a right angle
Triangles can have an obtuse angle
Use a protractor
Sometimes I think of "obese" angle
Every obtuse angle is less than 180°

Riddle and Clues

Have students write clues or riddles for vocabulary terms. For example:

I am the distance around a polygon (perimeter)

This word begins with an A

This word means the distance from zero that a number is on the number line

A symbol for this word is $||$ (absolute value)

Movement

Students can form concrete vocabulary using their bodies or movements. Post the word list on the board and ask students to show you:

Radius, circumference, area, perimeter, isosceles, multiplicative inverse, translation, rotation, bar graph, angle, line segment, hypotenuse, etc. This helps students focus on essential attributes and meanings.

Order and Steps

Procedures, measurement units, numbers, operations, and even story problems can be arranged into an order or steps. Give the students several chunks, parts or examples written in words or symbols on small cards and have them put these into an order or steps that is reasonable. Another way to do this is to give students a list and have them order the list.

Place these in the order you would use to find the surface area of a cylinder.

Find the base area. $A = \pi r^2$	Add the base area to the lateral area.	Find the lateral area. $A = 2\pi r \cdot h$	Multiply by 2
-----------------------------------	--	---	---------------

Order these units for measuring distance from least to greatest.

foot	yard	mile	inch
------	------	------	------

Foldables

A “Foldable” is a 3-D graphic organizer created by folding paper. Any concept or vocabulary can be put in a Foldable. Students can make Foldables and keep them in a gallon size zipper plastic bag for reference. Here are some examples.

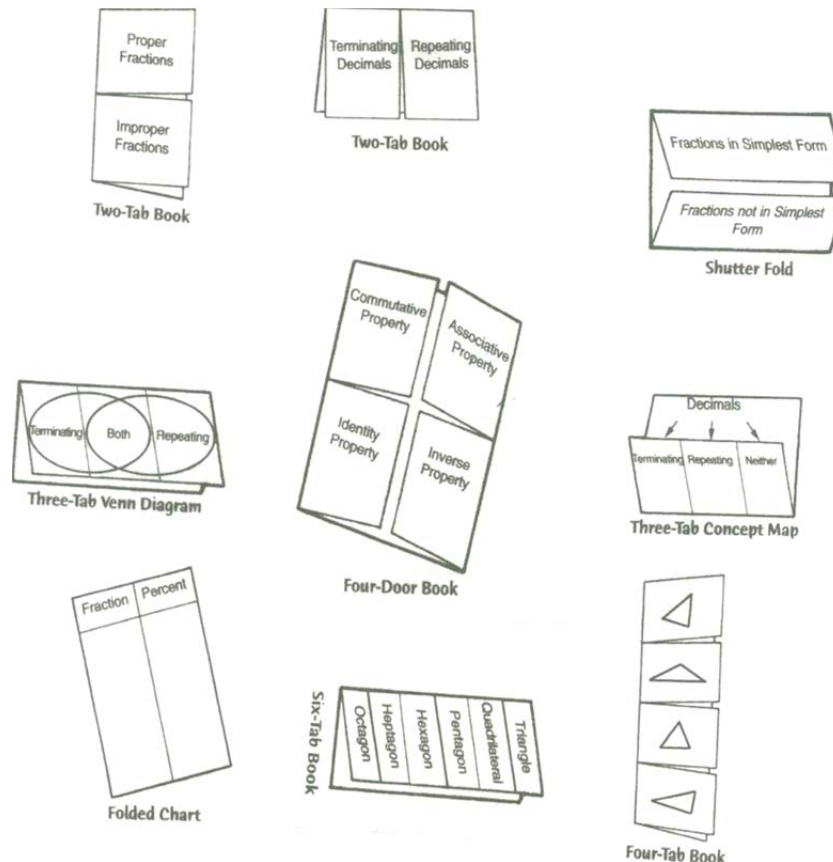

A Concept Map

After students have had several experiences to help them organize their understanding, a concept map gives them the opportunity to communicate their understanding by making connections, and citing examples. Display an example of a concept definition map. Model the use of the map discussing the questions a definition should answer:

- What is it? What broader category does it fit into?
- What can it be compared to?
- What is it like? What qualities make it different from other things in the same category? What are its characteristics or properties?
- What are some examples of it?

After students have created or helped create the map, have them write a complete definition of the word or concept.

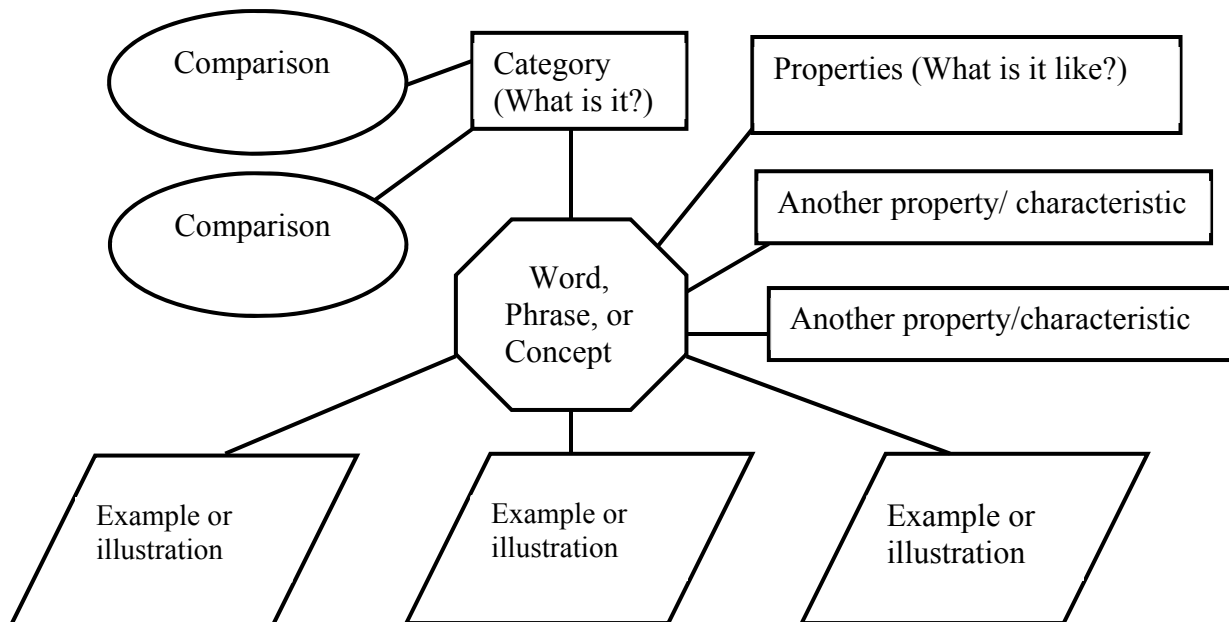

A Concept Map can include several concepts and vocabulary key to the unit. As the unit progresses, have students refine their maps with additional properties comparisons and examples.

The following examples show the Concept Map being used to define *Isosceles* and *Variable*.

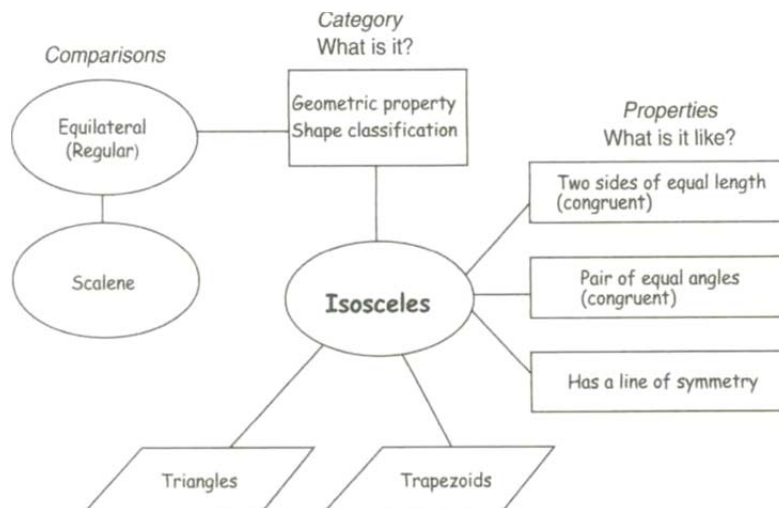

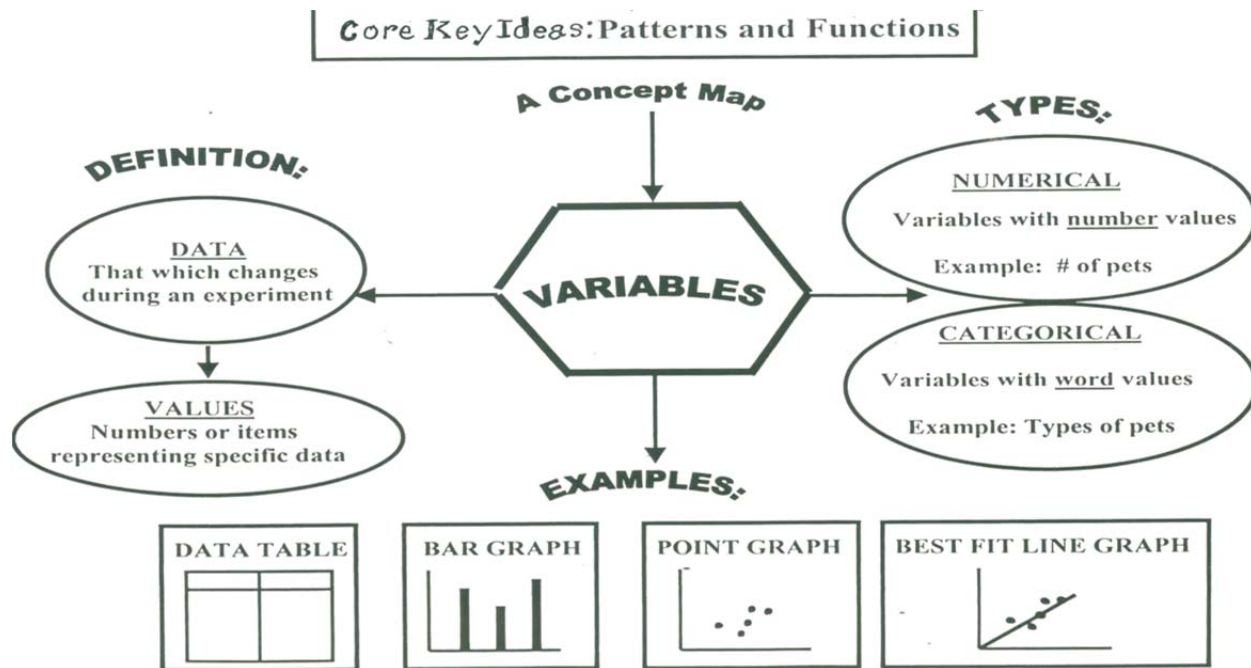

Step 5: Students Are Asked To Discuss Vocabulary with One Another

The opportunity to interact with others is another essential step in the development of mathematical language. Teachers become proficient in the use of mathematical vocabulary because they vocally use the language daily. If the teacher is the only person in the class speaking and discussing the vocabulary, the students are missing the social interaction necessary to correctly use the terms. Teachers should organize students into groups periodically and facilitate their discussion of the terms. This would occur as a regular part of the instruction.

Though discussion may occur as a typical part of the instruction, Marzano's research indicates occasionally students should be put into groups for the specific purpose of discussing the vocabulary. Students can be presented with vocabulary terms in small groups and asked to discuss their understanding of each term, adding to, changing or deleting information they may have previously had about the word. The new or expanded information gained from the small group discussion should be recorded in their academic notebooks or journals. Action research indicates that structure is needed to encourage and motivate students to engage in rich discussion.

A classroom environment where ideas, reasoning and approaches are encouraged and valued by all class members is necessary to this discussion. Teachers should encourage and support student use of mathematical language, and students should feel safe to venture such. All of the ideas previously suggested in this paper could include interactive discussion. However, to stimulate the discussion or structure the interaction, the following strategies may be helpful.

Cooperative Structures

Cooperative structures manage the interactive discussion in the classroom and are motivational. A structure is a strategy that includes positive interdependence, individual accountability, equal participation and simultaneous interaction-principles of cooperative interaction. Structures can be used effectively for vocabulary discussion as well as for a other mathematics objectives and purposes.

The following organizer gives the name of several structures, a description of the procedures and an indication of the purposes for which they may be best suited: Asking questions (Q), Mastery and practice of content (M), or Communication which may include information sharing, opinion, predicting, or summarizing (C).

30 Cooperative Structures at a Glance:

Name	Description	Q	M	C
Carousel	Teams rotate around the room stopping at stations where different terms or questions about terms are listed. Everything the students know about the words is discussed and written. Roles such as organizer, timer, gatekeeper and encourager may be rotated.		✓	✓
Fact or Fiction	Each student in a team writes three statements: two true and one false. Students take turns sharing their statement as teammates try to guess the false one.		✓	
Fan-N-Pick	Teammates play a card game to respond to questions. Each teammate has a role that rotates with each new question: Student one fans cards, another picks and reads, another explains or describes the term, another tutors or praises.	✓	✓	
People Search	Students mix around the room to find someone who knows the answer to a question from a list of questions or definitions the teacher has prepared. This can be done to help them mobilize background knowledge, learn content or skill, or identify characteristics, etc.	✓	✓	✓
Inside-Outside-Circle	Students form two concentric circles, so each person is facing a partner. Partners answer or discuss a question or word asked by the teacher. Teacher directs one of the circles to rotate, so new partnerships are formed.	✓	✓	✓
Match Mine	Partners sit on opposite sides of a barrier. One partner makes a sketch, or orders ideas about a word and attempts to direct the other partner to match the sketch or order by describing and explaining.		✓	✓
Mix-Freeze-Pair	Students mix around room until teacher says freeze. Students in close proximity become partners. Any person without a partner raises hand high and looks for another hand up to rush to. Students choose to be partner 1 or 2. Teacher gives a vocabulary terms or asks a question about that term, gives think time, then directs which partner will speak and which will listen. Students mix again for next question.	✓	✓	✓
Jigsaw or Team Jigsaw	Each team member studies a different vocabulary, then in turn, summarizes, explains or describes to team. The team adds to, corrects or deletes information. Or a team may study vocabulary together, then have team members each present part of the description to class. Each team is given different vocabulary.		✓	✓

Team Statement	Each person writes an individual description of a term. Then team works to use these to write a team description/definition statement to share with class.			✓
Four Corners	A different term is placed in each of the four corners of the room. One student from a team of four goes to a corner to meet with students from other teams to discuss the vocabulary. Returning to team, students take turns sharing information about their term with the team.		✓	✓
Rally Robin	In pairs students alternate oral responses. One gives a response, then the other adds to it, or one gives a response to the first question and the other to the second question or term.	✓	✓	✓
Rally Table	Same as Rally Robin, except response are written instead of given orally. The paper is passed back and forth between them.	✓	✓	✓
Rally Coach	In pairs, students take turns, one describing a term or answering a vocabulary question given by the teacher as the other dictates (coaches).		✓	✓
Round Robin	In teams, students take turns responding orally going around the team from student 1 to 2 to 3 to 4.	✓	✓	✓
Round Table	Same as Round Robin, except responses are written as a paper is passed around to each student. Or, each student simultaneously writes on their own paper, then pass their papers clockwise so each teammate can read and add to the prior responses.	✓	✓	✓
Numbered Heads Together	After thinking or writing their own descriptions or explanations, teammates put their “heads together” to add to or refine. The teacher then calls a number (1, 2, 3 or 4) and students with that number share their ideas with the class.	✓	✓	
Roving Reporter or Red Rover	Each team works together to answer a question or define and describe a term. Teacher calls for a student number to Rove (or teach another team). All Rovers move simultaneously. For a variation, called Red Rover, students can call for the person to come to their team to report.		✓	✓
Showdown	One teammate reads a term from a predetermined list out loud. Students work independently to describe or explain. When a teammate calls “Showdown!” all team members show their responses. They then refine, add to or change their own responses a.	✓	✓	
Pairs Check	One partner answers a question or describes a word as the other dictates (coaches). Additions or changes are discussed. They switch roles for the next term. After every two terms, pairs check with another pair and refine ideas.	✓	✓	
Think-Team-Share	A word is given or question asked by the teacher. All students think. Teacher calls out a student number. That student shares with team. Team celebrates or coaches. Some responses are shared with the class.	✓	✓	

Stand-n-Share	Teams work together to write a description or explanation for several words from a predetermined list. All teams stand simultaneously with a list of ideas they wrote about each word. The teacher selects one student to share an idea. Other teams check off that idea or add to it. Each team sits when all the ideas on its list have been shared.		✓	✓
Timed Pair Share	In pairs, students share with a partner for a period of time determined by the teacher while the other partner listens without interjecting. Then partners switch roles.			✓
Talking Tickets	During discussion or when making a list teammates place a chip, slip of paper, or pencil in the center of the table each time they talk. They cannot talk again until all the team members have placed their “ticket”.			✓
Mix-N-Match	Students mix around the room trying to find a partner whose card matches (same meaning or supporting information) theirs. A word could be on one card and a definition on another. Or, several ideas describing the term could be listed on several cards.		✓	✓
Three Step Interview	In pairs students take turns sharing information, then each person tell the team what their partner had to say.			✓
Write-Team-Board Game	Teams work to describe a term. Teacher calls a number (1, 2, 3, 4). All students assigned that number walk to the board simultaneously to write. Teams responding correctly with enough breadth earn a point.	✓	✓	
Value Lines	Students form a line, in order, according to a predetermined value (for example “How well you understand the word _____). Line is folded in half to form partners who discuss.		✓	✓
Telephone	A team member is sent out of the room while an explanation or information is given by the teacher. When the student returns, the team members take turns sharing one idea that was taught them.		✓	✓
Send A Problem or Puzzle	Each team writes an explanation, or description or makes a sketch representing the ideas. They create a puzzle by cutting apart the ideas or the sketch. When teacher signals, all teams send their puzzle to the next team. The receiving team responded on a different paper so the problem or puzzle can be sent to the next team, and the next as the problems or puzzles rotate around. Or, teams write an explanation for a term and send the explanation around the room for other teams to identify the word.	✓	✓	
Team Challenge Game	Each team makes a list of words and descriptions for these. A team member then asks the class explain or describe a word they choose to use as the challenge word. Students in the class are given time to discuss with their teammates. The challenging team then chooses one person in the class to explain. If that person’s response is satisfactory, their team earns a point. If not, teacher selects a student from the challenging team to explain, and the challenging team earns the point if their description is satisfactory.		✓	✓

Mind Map

Before beginning a unit, the student's background knowledge may be mobilized and a student's understanding may be deepened through a graphic discussion using a mind map. The teacher asks students to tell anything they know about a topic using the vocabulary they know. As students begin to offer ideas they remember, the teacher or other students add to, clarify or correct misunderstandings about the vocabulary. Students are asked where they see their ideas connected to others. An excellent review, this discussion can be very rich in vocabulary. Here is an example of a Mind Map generated by a discussion about data.

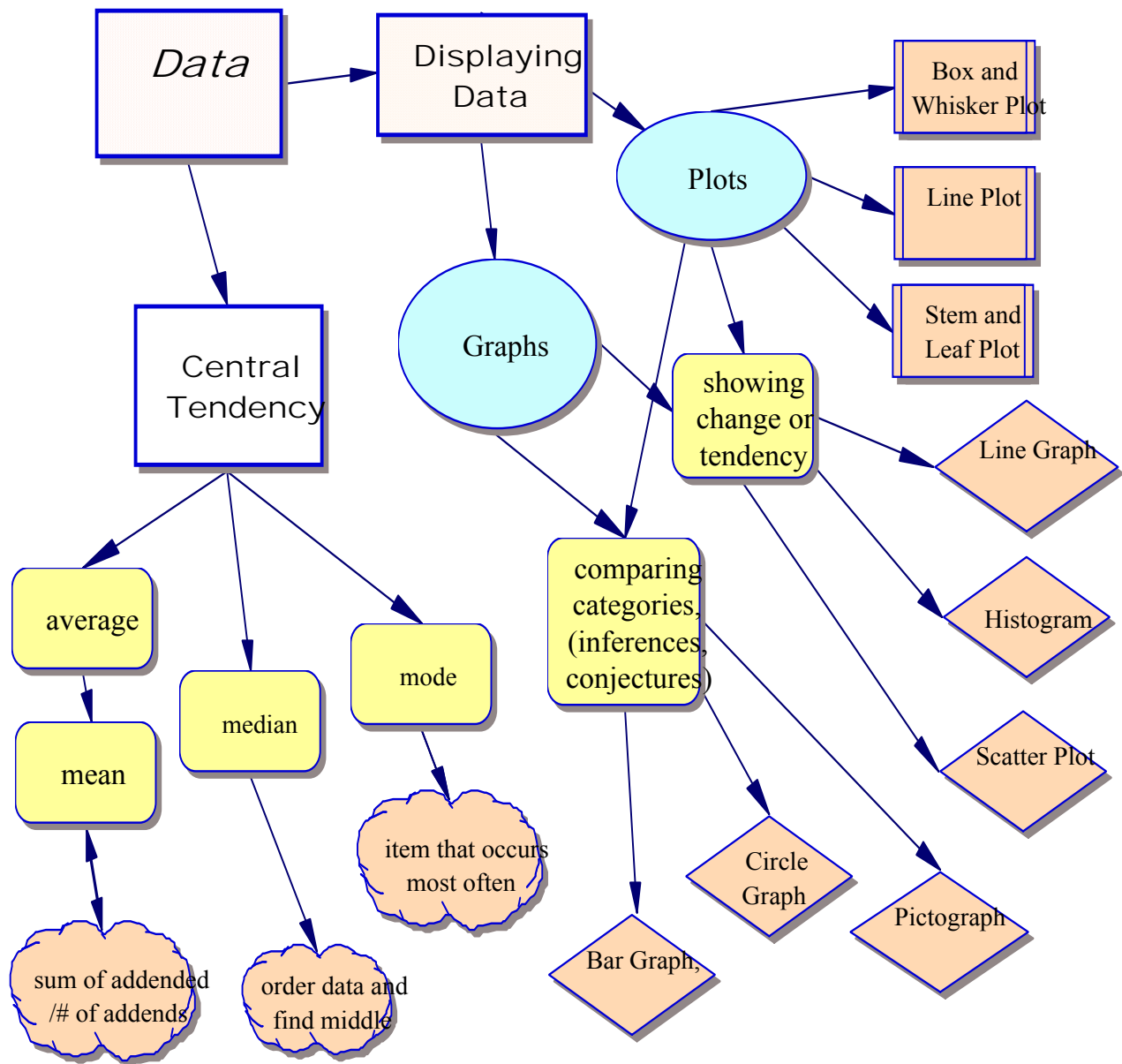

Word Sort

Giving small groups or pairs of students a list of words as suggested in Step 4, and asking them to sort them into categories can lead to rich discussion as each team or pair explains their categories to the class. Here is an example of words that can be cut apart and placed in an envelope for groups to sort and discuss.

Word Sort for Data Analysis

graph	Box plot	line plot
bar graph	circle graph	scatter plot
mean	average	median
mode	outlier	quartile
histogram	stem and leaf plot	predict
central tendency	pictograph	axes
x-axis	y-axis	extrapolate
interpolate	data sample	conjecture

Step 6: Periodically Students are Involved in Games to Allow Them to Play with the Terms

Games are a powerful instructional tool underused in schools. Research reported by Marzano lists three distinguishing characteristics for games: a) they present manageable challenges for students, b) they arouse curiosity, and c) create imaginary circumstances that stimulate growth. Games eliminate the drudgery of vocabulary instruction, engage students and motivate learning. A vocabulary game may be a short sponge activity to “soak up” short intervals of dead time during class, thus eliminating the need to add one more thing to a core already pressed for time, or may be integrated into instruction during a unit, lesson, or review.

Sponge Activity Games

These sponge activities can be done in a three to five minute time period, if only one round happens each class period. Or, the game can be extended to take more time if several rounds are played during one class period.

Pictionary

Teacher assigns each student a word from their academic notebook trying to match the complexity with the student’s readiness or levels of understanding. Students sketch clues to get others to guess their word.

Each day, one student is asked to try to get the class to guess their word as they present their sketches. A minute one point is given, if two minutes, the student gets two points. At the end of a two-week period of time a winner is declared. Students report they understanding vocabulary better as a result of this game.

Gambits

The class is divided into two teams. A student from each team is asked to come to the front of the class. Each of the two students is given an envelope with five terms inside. One is chosen to go first. Each student pulls out a word and gives their team clues to try to get them to guess the word. If the student has trouble with the word, another word may be chosen from the envelope. The team gets a point for each word guessed within a two-minute time limit. Points accumulate for a period of time. Winning team is rewarded.

Pantomime

A team of four or five students comes to the front of the class. One student is given a word to pantomime for their team. If the team is able to guess the word, the mime is given another word. Points are awarded for the number of words the team can guess in three minutes. After each team has had two turns over a period of days, the winning team is rewarded.

Fact or Fiction

A team writes two false statements and one true statement describing or explaining a vocabulary term. A team member reads the vocabulary term and the statements to the class. Class members are given 30 seconds to discuss the statement in small groups. The challenging team selects a person to identify which is the fictitious statement and to explain why. If the person does not identify the fictitious statement correctly, the team receives a reward. If the person does identify the fictitious statement correctly, that person's team receives the reward.

Nerf Ball Catch

A description, explanation or fill in the blank is presented. A Nerf Ball is then thrown to a student. Students get one point for catching and two points for telling the correct term.

Truth or Dare

A list of words is given to the class, or words are selected by students from their academic notebooks. A darer is asked to read a word to the class and instruct the class to "Tell the truth", about the word, or in other words, to give a true description and explanation of that word. The student then selects a class member to "Tell the truth" about the word. If the truth is not told, the selected class member is dared to do something such as bark like a dog, sing the first line of the Star Spangled Banner, perform a short ballet. The dares must be something that is appropriate for school and can be done in 10 seconds, and the teacher, of course, has veto power over any dare. The darer students must then give correct the description. If the student who was selected to tell the truth does so, the student is applauded and no dare is performed.

Longer Games

Sit Down If...

The object of this game is to use clues and the process of elimination to identify the correct word from a group of words the teacher has chosen. Students each draw a word from a bag of related terms that has been prepared by the teacher, and do not show other students. The words in the bag may all be different words, or there may be several of the same word(s). One of the terms is the word the teacher will be describing. All students stand. The teacher reads statements to the

class one at a time beginning with general information and moving to more specific information. Student(s) sit down if they believe the statement read, is not part of the meaning of their word. They remain standing if they believe the statement is part of the meaning of their word. Each student(s) who sits down is asked to read their word out loud, justify why they sat, and let the class decide if they agree or disagree. Each time a student sits down correctly, a point is given to the class. If a student sits down for a statement that does not characterize their word, the teacher gets the point. When the last statement in the description has been read, one or more students should be standing. Those holding the correct word each earn a point for the class. Those not holding the correct word earn a point for the teacher.

The game can be extended by having students keep their words for a second or third round. The teacher uses clue statements to identify a different word from the bag. To reduce risk, allow small groups to develop the list of words and the statements to characterize one of their words. They give one word from their list to each of the other teams. All students stand. As the statements developed by the challenging team are read, teammates from other teams discuss their word and *sit if they believe it is not* being described. Points go to teams who sit down at correct times and to the team left standing.

Here's an example for the word *rate*. These are the words in the bag:

Ratio	fraction	subtract	divide
Rate	quotient	difference	rational number

Possible characteristics statements in order from general to specific:

1. Can be used when you compare numbers
2. Can be written as a fraction
3. Is a comparison that uses division
4. Means "compared to" rather than "part out of whole"
5. Is used to compare different types of items or units
6. Is associated with the word *per* as in per mile, or per pound

Here is an example for the word *median*:

table	graph	plot
mean	median	mode

1. Is used to understand and analyze data
2. Is a way to measure central tendency
3. Data must be organized in order to find this.
4. Is the name for the data in the middle of a sample

Matching

Students make 15 matched pairs of vocabulary words and their descriptions or explanations. The word is written on an index card. Its definition is written on a different card. The cards are spread out face down in random order. Students work in pairs to match the word to its appropriate definition. One match entitles the student to a second try. Each time a match is made, that student keeps the card. The student who has collected the most cards at the end of the game wins. For a variation, have the students pairs make the cards and exchange them with another pair in the room.

Guess What

Students each write vocabulary and their descriptions on five cards and sign the cards. Students are asked to mingle around the room until teacher says, "Freeze". Students pair with a person closest to them. If a partner is not immediately available, students raise their hands and look around the room for another raised hand to pair with. Partners take turns trying to get the other partner to guess one of their words by telling them the description or explanation. If the partner guesses the word, they are given the card. At the teacher's signal, students mingle and freeze again to find a second partner, then a third, and so forth until they have had six or seven partners. At the end of the game, each student earns one point for each of the cards they have collected from others, and subtracts a point for each card of their own still in their hand. (This points system encourages students to do their best to help partners guess their words and try to guess other's words.)

Wheel of Fortune

Students play with a partner. Each student selects a word from a list of words given by the teacher and writes a description or explanation for that word. Then, partners take turns trying to guess the letters of the other partner's word by guessing one letter at a time. One partner guesses a letter of a word, then the other guesses a letter for the word they have been challenged to guess. The partner that guesses their word first gets 2 points. The game continues until both words have been guessed. Then, each partner must give a satisfactory definition for the word they were guessing. Correct definitions are worth 2 points. The game may have several rounds in a given time. At the end of the time, the partner with the most points wins.

Who Wants To Be A Millionaire? (Adaptation)

Student teams write 10 questions with four possible answer choices. The questions are examples of different vocabulary words, or descriptions or explanations. The possible answer choices are the vocabulary terms. Each question is assigned a monetary value according to difficulty in increments ranging from \$100 to \$1,000. They also write three more difficult questions worth of \$5,000, \$25,000 and \$100,000 respectively. Student groups compete to earn money for their team by answering another team's questions. During their turn, a team selects another team to supply their questions. The team may poll the class once and may eliminate 50% of the answer choices once. If a question is not answered correctly, the team loses their turn and any money they earned. A team may choose not to answer a question, end their turn, and retain any money they have earned to that point. Team with the greatest value wins.

Game Boards

(Adapted from Worksheets Don't Grow Dendrites, Marcia Tate, 2003)

Moving Ahead

Have students work in cooperative groups to construct an original game board following these guidelines:

- A. Provide 30 spaces including a beginning and an end space
- B. Include two move ahead spaces and two go back spaces.
- C. Make up question game cards describing vocabulary terms.
- D. Provide an answer key

Teams exchange games. To play, students on a team take turns rolling a die, moving the rolled number of spaces, selecting a card and telling the word described on their card. The first student in each group to get to the end of the game board wins.

Jeopardy

Students select key vocabulary words for a unit. They write a brief description, explanation or definition for the words. These descriptions, explanations or definitions are placed on a class game board in categories of 100, 200, 300, 400 and 500. The easiest are worth 100. The most difficult are worth 500 points. Student teams take turns asking the question for each of items on the game board. Questions are in this form: “What is/are (Word)?”

Concentration

A Concentration Board with lifting flaps is developed by the teacher. The flaps are numbered. Student teams create 3 x 5 cards to be taped under the flaps. One card shows a word. The other shows its characteristics, definition or explanation. The cards are placed under the flaps. The class is divided into two teams. A person from a team is called on to choose two flaps to try to match a word with its definition or description. The two flaps are lifted to show what is underneath. If that person makes a match, the person gets to choose two more flaps until they do not make a match. Then, a student from the other team is chosen to try to make a match. Each time a match is made, a point is awarded to the team.

Bingo

Provide each student with a 4 x 4 bingo card containing 16 blank spaces. Students randomly place vocabulary words from a list in the squares. Have students take turns pulling word descriptions or explanations from a bag and reading these aloud to the class. Students cover each word as its definition is read. The first to cover five words in a row, column or diagonally wins the game. When a student believes they have BINGO, have them read the words in a row and ask the class whether or not the explanation for that word has indeed been read. A variation of the game could be to show pictures, graphs or diagrams to the class for which show the meaning of the vocabulary rather than read descriptions and explanations.

Making Boxes

The teacher places an array of dots in a framed box on the board. The class is divided into two teams. Teacher selects a word from a predetermined list for small groups or pairs to discuss for 15 seconds. A student from a one team is then selected to give the description, explanation or examples for that word without further coaching or help from group or partner. If the response is correct, the student goes to the game board and draws in two lines (horizontal or vertical) connecting points to form a box. When a box is formed, the student puts the team number inside the box to show who earned that box and sketches one more vertical or horizontal line connecting two points anywhere else on the game board. The next question goes to the next team. This continues until all the board has been made into boxes. The team earning the most boxes wins the game.

Game like Activities

Finally, game-like activities can also be used to move meaning into permanent memory. Following are several ideas suggested by teachers.

Vocabulary Walk-Aways

Put several vocabulary terms on 3x5 cards with brief definitions. The last few minutes of class ask all students to stand. Pick a card and read the word. Call on someone who raises their hand. If they get it right, they sit down. There are some variations. Sometimes I ask that person for their birth month. If they were born in June, then everyone born in June sits. Sometimes the person getting the correct answer gets to pick someone and they both sit down. Students love this game, and it is very effective in developing basic vocabulary.

Calculator Challenge

Give students a vocabulary list or let them use vocabulary in their journals or academic notebooks. Give student pairs a graphing calculator. The teacher begins by saying a word from the list that can be explained or shown on the calculator and challenging the class to show an example or explanation (numbers, text, graph, sketch, list, application etc) on a graphing calculator. After a reasonable time has passed, have the students get up and walk around the room in pairs taking their calculator with them. The teacher says “Freeze”, and each pair pairs with two students in close proximity. The pairs show and explain their calculator screens and decide if either or both are good examples of the vocabulary. If a pair thinks their partners have a GREAT example, they nominate them to show or explain to the class. Students return to their desks and the teacher selects one or two nominees. The next word for the challenge may be selected by the teacher, one of the nominees or another student and the activity continues. This activity can be done as a sponge using one word at a time to fill a few extra minutes.

Word Puzzles

Word search from definitions given or crossword puzzles can be helpful.

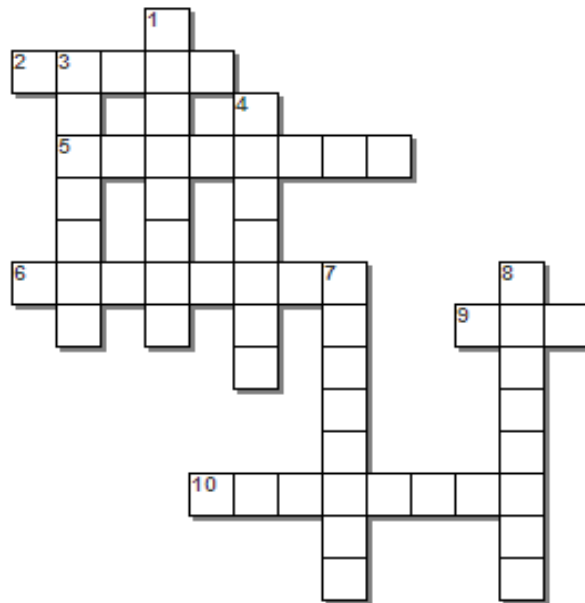

Across:

1. unit of weight
3. a type of math
4. shape
7. math sentence
8. answer

Down:

2. comparison
5. a type of math
6. shape
9. answer
10. substitute for unknown

Bibliography and Resources

Building Background Knowledge For Academic Achievement Research on What Works In Schools
Robert J Marzano, 2004, Association for Supervision and Curriculum Development, Alexandria, VA

Cooperative Learning. Dr. Spencer Kagan, 1998, Kagan Cooperative Learning, San Clemente, CA

Worksheets Don't Grow Dendrites. Marcia L. Tate, 2003, Corwin Press, Thousand Oaks, CA

Teaching Reading In Mathematics. Mary Lee Barton and Clare Heidema, 2002, McREL, Association for Supervision and Curriculum Development, Alexandria, VA

Reading In The Content Areas, Mathematics. Based on the work of Walter Pauk, 2005, McGraw Hill/Glencoe, New York, NY

Super Teaching. Eric Jensen, 1995, The Brain Store, San Diego, CA

Writing To Learn Mathematics, Strategies That Work. Joan Countryman, 1992, Heinemann, Portsmouth, NH

Teaching Mathematics With Foldables. Dinah Zike, Glencoe/McGra-Hill, New York, NY

Teaching With Graphic Organizers. EdHelp.com

Principals and Standards For School Mathematics. 2000, National Council Of Teachers Of Mathematics, Reston, VA